



Quality Products. Service Excellence.

# Low Voltage PCB Mount - Epoxy Cast - 1 VA to 40 VA 226-227-228 Series

## Features

- Primary 115 VAC, 60 or 400Hz. models, 3 case sizes
- Epoxy cast to withstand shock and severe environments
- Two coil design provides balanced windings and low magnetic radiation - no electrostatic shield required.
- 228 series include four, 6-32 X .38 machine screw inserts for less strain on p.c. board connections.

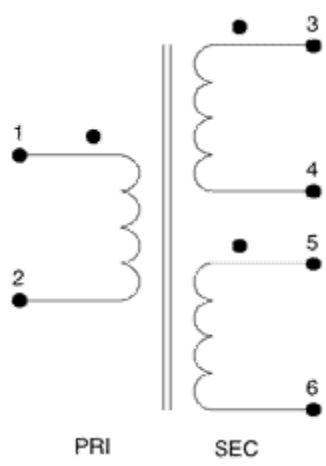
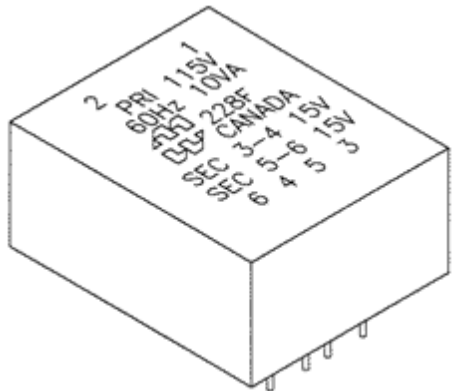
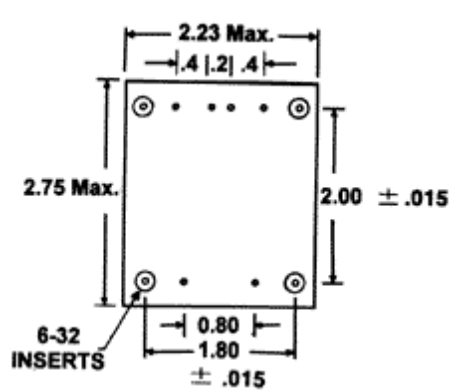
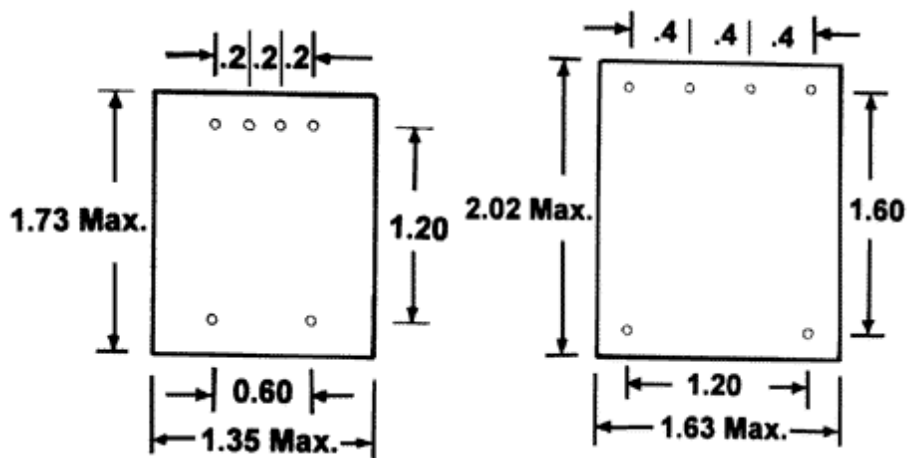

**226 Series:**

Part No.	Size Freq.		Secondary (RMS)		Temp. Rise (C)	% Regulation	High Max	Pin Diameter	Weight lbs.
	(VA)	(Hz)	Series	Parallel					
226D	1	60	20V C.T. @ 50ma	10V @ 100ma	25	19.7	0.8	0.04	0.22
226F	1	60	30V C.T. @ 34ma	15V @ 67ma	25	21.7	0.8	0.04	0.22
226H	1	60	40V C.T. @ 25ma	20V @ 50ma	25	18.9	0.8	0.04	0.22
226N	20	400	20V C.T. @ 1A	10V @ 2A	35	7.2	0.8	0.04	0.22
226P	20	400	26V C.T. @ 770ma	13V @ 1.54A	35	7.6	0.8	0.04	0.22
226R	20	400	30V C.T. @ 670ma	15V @ 1.33A	35	7.5	0.8	0.04	0.22
226T	20	400	40V C.T. @ 500ma	20V @ 1A	35	7.2	0.8	0.04	0.22

**227 Series:**

Part No.	Size Freq.		Secondary (RMS)		Temp. Rise (C)	% Regulation	High Max	Pin Diameter	Weight lbs.
	(VA)	(Hz)	Series	Parallel					
227D	5	60	20V C.T. @ 250ma	10V @ 500ma	25	20.07	1.05	0.05	0.38
227F	5	60	30V C.T. @ 170ma	15V @ 340ma	25	24	1.05	0.05	0.38
227H	5	60	40V C.T. @ 125ma	20V @ 250ma	25	26	1.05	0.05	0.38
227N	40	400	20V C.T. @ 2A	10V @ 4A	45	6	1.05	0.05	0.38
227P	40	400	26V C.T. @ 1.54A	13V @ 3.08A	45	5.7	1.05	0.05	0.38
227R	40	400	30V C.T. @ 1.33A	15V @ 2.66A	45	6	1.05	0.05	0.38
227T	40	400	40V C.T. @ 1A	20V @ 2A	45	5.7	1.05	0.05	0.38

**228 Series:**

Part No.	Size Freq.		Secondary (RMS)		Temp. Rise (C)	% Regulation	High Max	Pin Diameter	Weight lbs.
	(VA)	(Hz)	Series	Parallel					
228D	10	60	20V C.T. @ 500ma	10V @ 1A	20	12.2	1.22	0.50	0.91
228F	10	60	30V C.T. @ 340ma	15V @ 670ma	20	12.5	1.22	0.50	0.91
228H	10	60	40V C.T. @ 250ma	20V @ 500ma	20	12.2	1.22	0.50	0.91

*Data subject to change without notice*

© 2021. Hammond Manufacturing Ltd. All rights reserved.